



張力/糾偏/卷材控制專家
LEADING COMPANY OF TENSION CONTROL AND WEB GUIDING



糾偏控制系統

WEB GUIDING CONTROL SYSTEM

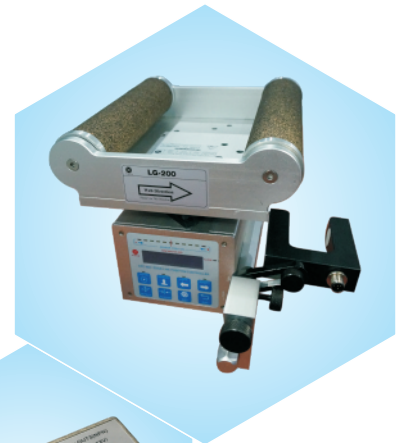
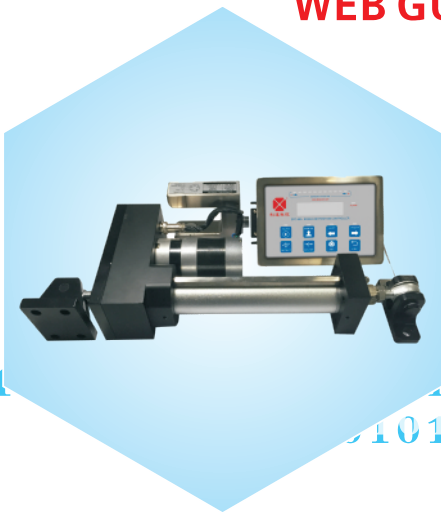

111110100
101101001

東莞市萊森精密機電有限公司

DONGGUAN LEESUN Precision Mechtronics Co.,Ltd

工業用離合器|制動器|張力控制系統|糾偏系統



公司簡介 ABOUT US



利迅科技工業有限公司始創于臺灣,擁有專業的設計研發團隊,主要研發生產高精密磁粉式離合器/制動器、電磁式離合器/制動器、氣壓式離合器/制動器、張力控制系統、糾偏控制系統等工業產品,為卷取設備行業提供各種張力控制、糾偏控制解決方案。產品質量優異,廣受客戶好評,使“**利迅LEESUN**”品牌成為行業的領導者。產品廣泛應用於包裝機械、印刷機械、電子電池設備、電纜電纜機械、制紙制版機械、橡塑機械、食器機械、紡織機械、玻璃機械、木工機械等行業。

經過不斷發展,為了適應市場的需要,公司于1996年在福建建立生產基地,同時在東莞成立分公司——**東莞市萊森精密機電有限公司**,全面負責大陸地區的銷售業務。

東莞市萊森精密機電有限公司以優質的產品和真誠服務歡迎廣大新老客戶垂詢合作,共同發展!



光电纠偏控制器 EPC-D12

EPC-D12型光电纠偏控制器是一种跟踪工作材料的边缘或印刷线条进行差动和摆动可选择纠偏控制器。EPC-D12是由大规模工业集成电路组成，具有恶劣工作环境抗干扰能力强，可靠性高，使用寿命长等优点，很适应包装行业连续不停机生产工作需要，它已广泛应用到塑料薄膜分切机、分切机、涂布机、印刷机、复合机等设备上。EPC-D12可配上开关量传感器，同步电机执行器构成一套稳定可靠的纠偏系统。

功能特点

- 可手动/自动工作
- 可工作于对边，对线方式
- 单/双电眼输入
- 响应速度可调
- 带限位输入
- 纠偏精度 $\leq 1\text{mm}$
- 驱动单相同步电机



安装方式

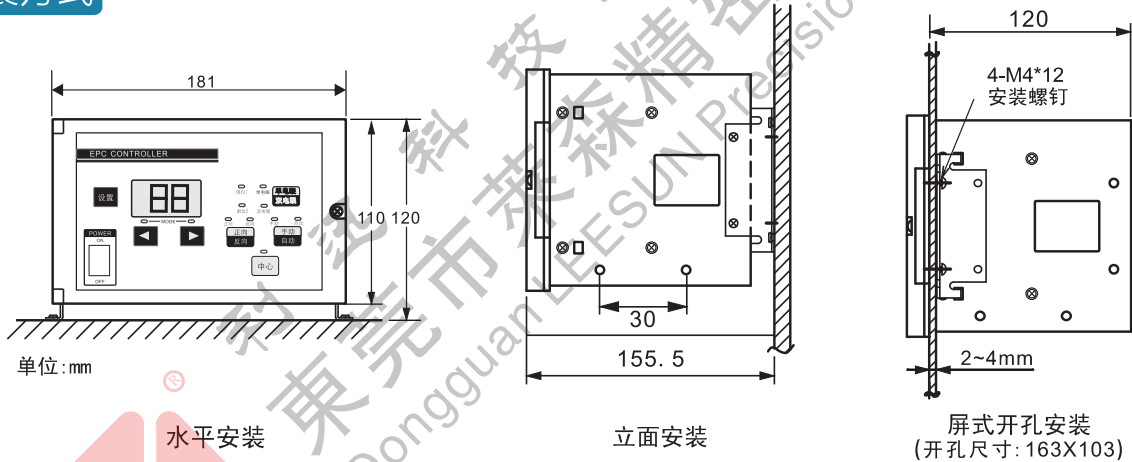

接线图

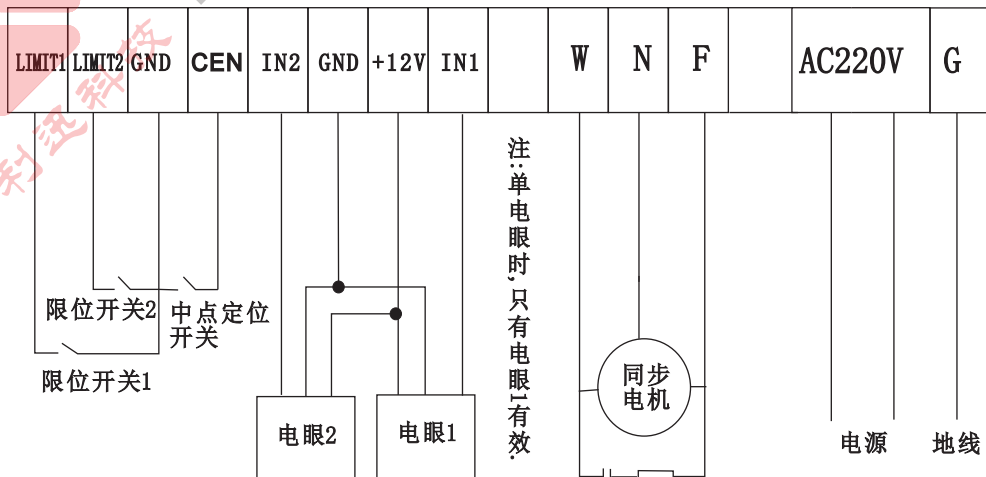



我们的产品 Application Show

➤ 张力控制系列

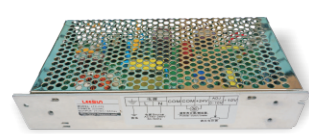

➤ 检测器系列



➤ 离合器制动器系列

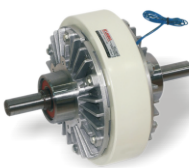

➤ 气胀轴铝导辊胶辊系列

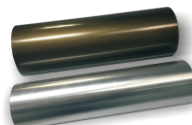
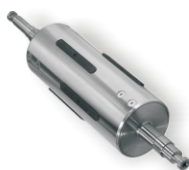

更多產品資訊請訪問：www.leesuncn.com

或致電：400-888-5212，我們豐富經驗的工程師團隊樂于為您提供服務！



品質決勝未來

Quality winning the future

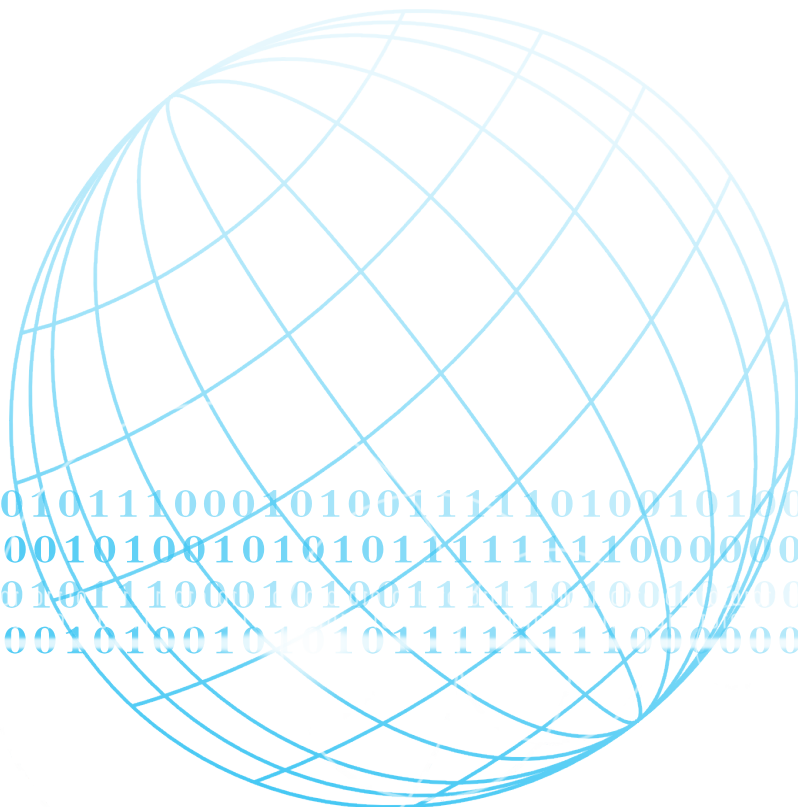

100101011100010100111110100101001101
1100001010010101011111111000000010000000
100101011100010100111110100101001101
11000010100101010111111100000001000000



利迅科技

利迅科技工業有限公司

LEESUN Technology Industrial Co., Ltd

臺灣：臺北縣汐止市大同路三段372號

電話：886-2-8648 7482

傳真：886-2-8648 0915

網址：www.leesuncn.com

郵箱：sales@leesuncn.com

大陸工廠

地址：福建省福州市倉山區浦上工業區

郵箱：sales@leesuncn.com

華南公司

東莞市萊森精密機電有限公司

DONGGUAN LEESUN Precision Mechtronics Co.,Ltd

地址：廣東省東莞市南城區第一國際百安中心B303

電話：0769-85189162/85180215/26980325

傳真：0769-81610656

網址：www.leesuncn.com

郵箱：leesun@leesuncn.com

全國免費服務熱綫

400-888-5212